

Kinghelm®

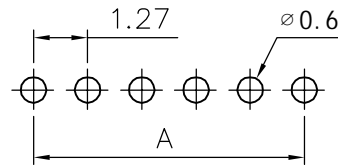

RECOMMEND P. C. B LAYOUT
PCB TOLERANCE: ±0.05 (TOP VIEW)

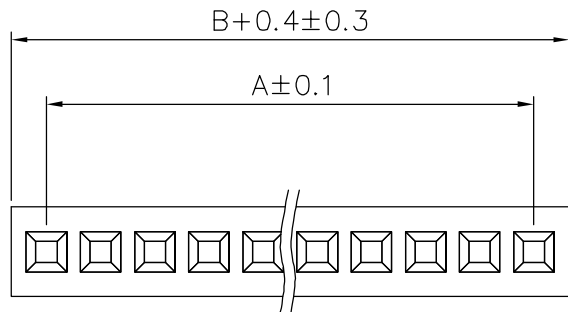
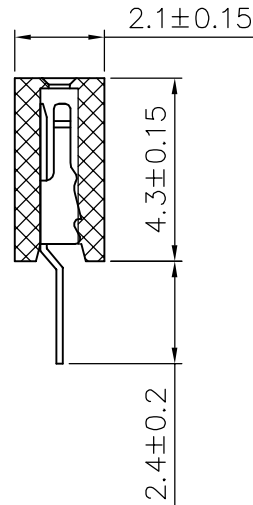
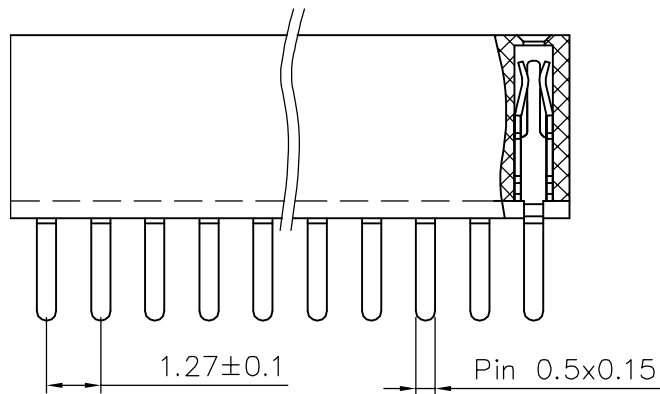

SPECIFICATIONS

Current Rating: 1.0 Amps
 Withstanding Voltage: AC 500V
 Insulation Resistance: 1000MΩ Min
 Contact Resistance: 20 mΩ Max
 Operation Temperature: -40 ° to +105 °
 Insulator Material: Polyester (UL94V-0)
 Contact Material: Phosphor bronze
 Standard: PA6T
 Contact Plating: Gold Flash
 Max. Processing Temp: 240 ° C for 30-60 seconds
 (260 ° C for 5 seconds)

- (1) Pin Spacing: 127=1.27mm
- (2) Product Name: FH=Female Header
- (3) No. of Rows: 1=Single Row ; 2=Dual Row
- (4) No. of Pins Per Row: 1~50
- (5) Insulator Material Height: 20=2.0mm; 43=4.3mm
- (6) Connector Type: S=Straight; R=Right; Angle M=SMT
- (7) Connector Material Length: 24=2.4mm; 30=3.0mm
- (8) Insulator Material Width: 18=1.8mm 21=2.1mm
- (9) Contact Plating: G0=Gold Flash; AU10=Au 1.0u"
- (10) Insulator Material Option:
A=BK-PA6T; B=BK-PA46; C=KB-LCP; S=Special

深圳市金航标电子有限公司

WWW.BDS666.COM

KH-1.27FH-1X14P-H4.3

0755-83044319

UNLESS OTHERWISE SPECIFIED TOLERANCE
 X : ±0.3 X° : ±5°
 X.X : ±0.2 X.X° : ±1°
 X.XX : ±0.1 X.XX° : ±0.5°

DRAWM NAME

1.27FH 1x8Pin H4.3 DIP

SIZE	A4	SCALE	N:1	PROJECT NO.
REV	A	UNIT	mm	PROJECT



PAGE 1/1

DRAW: LI BEI LIN 12/03/07 CHECKED: / / APPROVED: / /

No. of	DIM. A	DIM. B	No. of	DIM. A	DIM. B	No. of	DIM. A	DIM. B	No. of	DIM. A	DIM. B	No. of	DIM. A	DIM. B
1	—	—	11	12.70	13.97	21	25.40	26.67	31	38.10	39.37	41	50.80	52.07
2	1.27	2.54	12	13.97	15.24	22	26.67	27.94	32	39.37	40.64	42	52.07	53.34
3	2.54	3.81	13	15.24	16.51	23	27.94	29.21	33	40.64	41.91	43	53.34	54.61
4	3.81	5.08	14	16.51	17.78	24	29.21	30.48	34	41.91	43.18	44	54.61	55.88
5	5.08	6.35	15	17.78	19.05	25	30.48	31.75	35	43.18	44.45	45	55.88	57.15
6	6.35	7.62	16	19.05	20.32	26	31.75	33.02	36	44.45	45.72	46	57.15	58.42
7	7.62	8.89	17	20.32	21.59	27	33.02	34.29	37	45.72	46.99	47	58.42	59.69
8	8.89	10.16	18	21.59	22.86	28	34.29	35.56	38	46.99	48.26	48	59.69	60.96
9	10.16	11.43	19	22.86	24.13	29	35.56	36.83	39	48.26	49.53	49	60.96	62.23
10	11.43	12.70	20	24.13	25.40	30	36.83	38.10	40	49.53	50.80	50	62.23	63.50